

***CATALOGUE 2013***

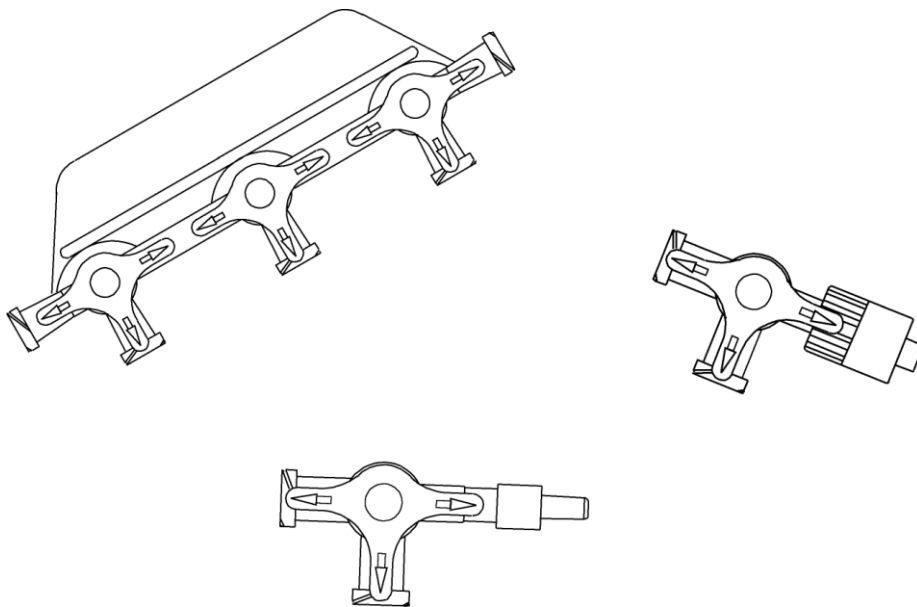

***POLYCARBONATE STOPCOCKS  
MANIFOLDS - CONNECTORS***

POLYMED s.r.l. Milano  
tel. 02 69015192  
email: [polymed.srl@gmail.com](mailto:polymed.srl@gmail.com)  
[www.polymedsrl.it](http://www.polymedsrl.it)

## **General Information**

### **COMPLIANCE PRODUCT**

The Luer taper fittings are conform to standard ISO 594-1 for syringes, needles and other medical devices. The diverter valve is lubricated with silicone oil in quantities less than 0.25 mg. Moulding and assembly are made in clean room.

### **CERTIFICATIONS**

The materials are certified by the manufacturers according to ISO 10993-1 - Biological evaluation of medical devices and U. S. Pharmacopoeia, Class VI.

Polymed performs periodically in a laboratory certified UNI EN ISO 13485 Quality System for Medical, testing components contamination (Bio burden).

The activity of moulding has place in one third Company under control and responsibility to Polymed , the company is certified ISO 9001.

### **PACKAGING AND STORAGE**

The products are packed in double bag and corrugated cardboard box.

The label identifies the product, batch number and the customer's order.

The products are Stored in a cool dry place away from sunlight and heat, at temperatures between 50° and 95° F (10°- 35° C).

### **TECHNICAL NOTES**

The flow evaluation test was performed with physiological solution, the stopcock connected with a PVC pipe dia. 3x4.1, of 1 m length.

## 3-Way Stopcock with Luer Lock

Art. No: 9284\*\*

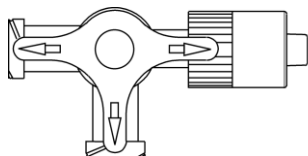

Stopcock with 2 female Luer ports, male Luer Lock.  
360° Rotating diverter, lubricated with silicone oil  
Automatic assembly in Clean Room.

Flow rate 310 ml/min  
Residual vol. 0,2 ml  
Max pressure 8 bar – 116 psi  
Drawing 502

<i>elements</i>	<i>material</i>	
	<i>lipid resistant</i>	<i>polycarbonate</i>
Body	PC Makrolon, purple	PC Lexan, transparent
Diverter	HDPE coloured	
Rotating	ABS transparent	
sterilize	gamma, EtO	EtO

  

<i>Diverter colours</i>	<i>Art. No.</i>	<i>Art. No.</i>
<i>White</i>	928450	928420
<i>Red</i>	928452	928422
<i>Blue</i>	928453	928423
<i>Yellow</i>	928454	928424

PACKAGING: No. 3,000 pcs. in bulk  
cm 30x42x30 - kg 9.300  
inch 11.8x16.5x11.8 - lb 20.5  
Vol. 0.037 m<sup>3</sup>

## 3-Way Stopcock Luer Lock with Caps

Art. No. 9884\*\*

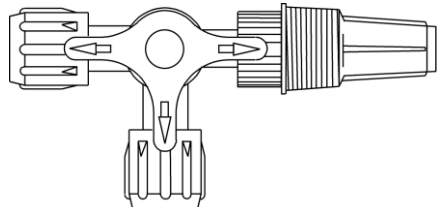

Stopcock with 2 female Luer ports with caps,  
Luer Lock with vented cap.  
360° Rotating diverter, lubricated with silicone oil  
Automatic assembly in Clean Room.

Flow rate 310 ml/min  
Residual vol. 0,2 ml  
Max pressure 8 bar – 116 psi  
Drawing 513

<i>elements</i>	<i>material</i>	
	<i>lipid resistant</i>	<i>polycarbonate</i>
Body	PC Makrolon, purple	PC Lexan, transparent
Diverter	HDPE coloured	
Rotating	ABS transparent	
Vented Cap	Polyethylene	
Male Caps	ABS (blue, white)	
sterilize	gamma, EtO	EtO

<i>Diverter colours</i>	<i>Art. No.</i>	<i>Art. No.</i>
<i>White</i>	988450	988420
<i>Red</i>	988452	988422
<i>Blue</i>	988453	988423
<i>Yellow</i>	988454	988424

PACKAGING: No. 3,000 pcs. in bulk  
cm 40x40x37 - kg 14.16  
inch 15.76x15.76x14.56 - lb 31.22  
Vol. 0.06 m<sup>3</sup>

## 3-Way Stopcock Fit 3x4 Tubing

Art. No. 9286\*\*

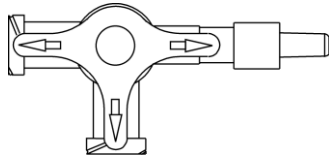

Stopcock with 2 female Luer ports, fits 3x4.1 mm tubing.  
360° Rotating diverter, lubricated with silicone oil  
Automatic assembly in Clean Room.

Flow rate 310 ml/min  
Residual vol. 0,2 ml  
Max pressure 8 bar – 116 psi  
Drawing 509

<i>elements</i>	<i>material</i>	
	<i>lipid resistant</i>	<i>polycarbonate</i>
Body	PC Makrolon, purple	PC Lexan, transparent
Diverter	HDPE coloured	
sterilize	gamma, EtO	EtO

<i>Diverter colours</i>	<i>Art. No.</i>	<i>Art. No.</i>
<i>White</i>	928650	928620
<i>Red</i>	928652	928622
<i>Blue</i>	928653	928623
<i>Yellow</i>	928654	928624

PACKAGING: No. 3,500 pcs. in bulk  
cm 30x42x30 - kg 8.7  
inch 11.8x16.5x11.8 - lb 19.18  
Vol. 0.037 m<sup>3</sup>

## 3-Way Stopcock Fit 3x4 Tubing with 2 Caps

Art. No. 9886\*\*

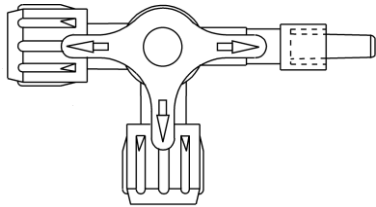

Stopcock with 2 female Luer ports with caps, fits 3x4.1 mm tubing.  
360° Rotating diverter, lubricated with silicone oil  
Automatic assembly in Clean Room.

Flow rate 310 ml/min  
Residual vol. 0,2 ml  
Max pressure 8 bar – 116 psi  
Drawing 515

<b>elements</b>	<b>material</b>	
	<b>lipid resistant</b>	<b>polycarbonate</b>
Body	PC Makrolon, purple	PC Lexan, transparent
Diverter	HDPE coloured	
Male Caps	ABS (blue, white)	
sterilize	gamma, EtO	EtO
<b>Diverter colours</b>	<b>Art. No.</b>	<b>Art. No.</b>
White	988650	988620
Red	988652	988622
Blue	988653	988623
Yellow	988654	988624

PACKAGING: No. 2,500 pcs. in bulk  
cm 30x42x30 - kg 9.0  
inch 14.18x16.5x14.18 - lb 19.8  
Vol. 0.037 m<sup>3</sup>

## 3-Way Stopcock with Luer Slip

Art. No. 9282\*\*

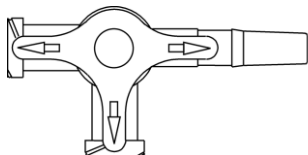

Stopcock with 2 female Luer ports and Luer Slip.  
360° Rotating diverter, lubricated with silicone oil  
Automatic assembly in Clean Room.

Flow rate 310 ml/min  
Residual vol. 0,2 ml  
Max pressure 8 bar – 116 psi  
Drawing 501

<b>elements</b>	<b>material</b>	
	<b>lipid resistant</b>	<b>polycarbonate</b>
Body	PC Makrolon, purple	PC Lexan, transparent
Diverter	HDPE coloured	
sterilize	gamma, EtO	EtO

<b>Diverter colours</b>	<b>Art. No.</b>	<b>Art. No.</b>
<i>White</i>	928250	928220
<i>Red</i>	928252	928222
<i>Blue</i>	928253	928223
<i>Yellow</i>	928254	928224

PACKAGING: No. 3,500 pcs. in bulk  
cm 30x42x30 - kg 8.63  
inch 11.8x16.5x11.8 – lb 18.96  
Vol. 0.037 m<sup>3</sup>

## 3-Way Stopcock Fit 4 mm OD Tubing

Art. No. 9288\*\*

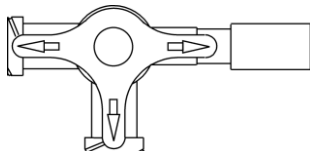

Stopcock with 2 female Luer ports, fits 4.1 mm OD tubing.  
360° Rotating diverter, lubricated with silicone oil  
Automatic assembly in Clean Room.

Flow rate 310 ml/min  
Residual vol. 0,2 ml  
Max pressure 8 bar – 116 psi  
Drawing 520

<b>elements</b>	<b>material</b>	
	<b>lipid resistant</b>	<b>polycarbonate</b>
Body	PC Makrolon, purple	PC Lexan, transparent
Diverter	HDPE coloured	
sterilize	gamma, EtO	EtO

<b>Diverter colours</b>	<b>Art. No.</b>	<b>Art. No.</b>
<i>White</i>	928850	928820
<i>Red</i>	928852	928822
<i>Blue</i>	928853	928823
<i>Yellow</i>	928854	928824

PACKAGING: No. 3,500 pcs. in bulk  
cm 30x42x30 - kg 8.96  
inch 11.8x16.5x11.8 - lb 19.8  
Vol. 0.037 m<sup>3</sup>



## 3-Way Stopcock Fit 2.5 mm OD Tubing

Art. No. 9287\*\*

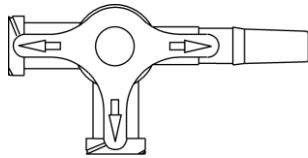

Stopcock with 2 female Luer ports, fits 2.5 mm OD tubing.  
360° Rotating diverter, lubricated with silicone oil  
Automatic assembly in Clean Room.

Flow rate 310 ml/min  
Residual vol. 0,2 ml  
Max pressure 8 bar – 116 psi  
Drawing 514

<i>elements</i>	<i>material</i>	
	<i>lipid resistant</i>	<i>polycarbonate</i>
Body	PC Makrolon, purple	PC Lexan, transparent
Diverter	HDPE coloured	
sterilize	gamma, EtO	EtO

<i>Diverter colours</i>	<i>Art. No.</i>	<i>Art. No.</i>
<i>White</i>	928750	928720
<i>Red</i>	928752	928722
<i>Blue</i>	928753	928723
<i>Yellow</i>	928754	928724

PACKAGING: No. 3,500 pcs. in bulk  
cm 30x42x30 - kg 8.63  
inch 11.8x16.5x11.8 - lb 18.96  
Vol. 0.037 m<sup>3</sup>

## Stopcock Manifold

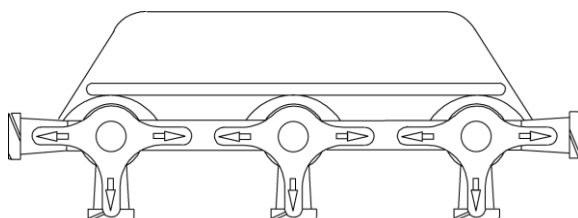

2, 3, 4 or 5 Stopcock manifold with female ports.  
 Lipid resistant; Max. pressure 5 bar – 72 psi  
 360° Rotating diverter, lubricated with silicone oil  
 Hand assembled in Clean Room.

<i>elements</i>	<i>material</i>
Body	PC Makrolon, purple
Diverter	HDPE coloured
sterilize	gamma, EtO

<b>No. Stopcocks</b>	<b>Art. No.</b>	<b>No. female ports</b>	<b>colour diverters</b>	<b>pcs./box</b>	<b>No. drawing</b>
2	932 550	4	White Blue	900	525
3	933 550	5	Red White Blue	550	506
4	934 550	6	Red Yellow White Blue	400	523
5	935 550	7	Red Green Yellow White Blue	340	508

PACKAGING: in bulk.  
 cm 30x42x30  
 inch 11.8x16.5x11.8  
 Vol. 0.037 m<sup>3</sup>

## Stopcock Manifold with Luer Lock

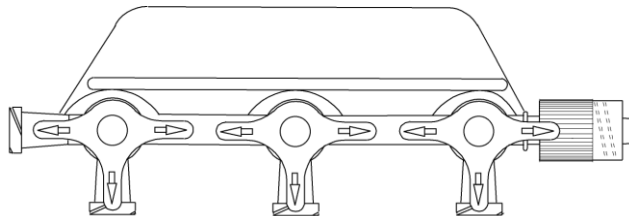

2, 3, 4 or 5 Stopcock manifold with one Luer lock connector and female Luer ports.

Lipid resistant; Max. pressure 5 bar – 72 psi

360° Rotating diverter, lubricated with silicone oil

Hand assembled in Clean Room.

<i>elements</i>	<i>material</i>
Body	PC Makrolon, purple
Diverter	HDPE coloured
Rotating	ABS transparent
sterilize	gamma, EtO

<b>No. Stopcocks</b>	<b>Art. No.</b>	<b>No. female ports</b>	<b>colour diverters</b>	<b>pcs./box</b>	<b>No. drawing</b>
2	932250	3	White Blue	900	519
3	933250	4	Red White Blue	500	517
4	934250	5	Red Yellow White Blue	400	524
5	935250	6	Red Green Yellow White Blue	340	518

PACKAGING: in bulk.  
 cm 30x42x30  
 inch 11.8x16.5x11.8  
 Vol. 0.037 m<sup>3</sup>

POLYMED s.r.l. Milano  
 tel. 02 69015192  
 email: [polymed.srl@gmail.com](mailto:polymed.srl@gmail.com)  
[www.polymedsrl.it](http://www.polymedsrl.it)

## Luer Lock Tubing Connector

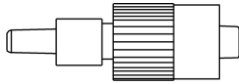

Male Luer Lock connector with rotating sleeve,  
fits 3x4.1 mm tubing.  
Assembled automatically in Clean Room.

**Art. No.**            Flow rate        410 ml/min  
**964411**            Residual vol.   0,1 ml  
                         Drawing            512

<i>elements</i>	<i>material</i>
Body	ABS transparent
Rotating	ABS White
sterilize	EtO

PACKAGING: No. 10,000 pcs. in bulk  
cm 30x42x30 - kg 10.9  
inch 11.8x16.5x11.8 – lb 24.0  
Vol. 0.037 m<sup>3</sup>

## Luer Lock Tubing Connector with Hydrophobic Filter

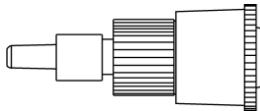

Male Luer Lock connector with rotating sleeve  
and hydrophobic filter cap pore size 0.8 µm,  
fits 3x4.1 mm tubing.  
Assembled automatically in Clean Room.

**Art. No.**            Flow rate        410 ml/min  
**964911**            Residual vol.   0,1 ml  
                         Drawing            511

<i>elements</i>	<i>material</i>
Body	ABS transparent
Rotating	ABS White
Cap	HDPE
sterilize	EtO

PACKAGING: No. 7,000 pcs. in bulk  
cm 30x42x30 - kg 12.14  
inch 11.8x16.5x11.8 - lb 26.76  
Vol. 0.037 m<sup>3</sup>